

DORSI

A

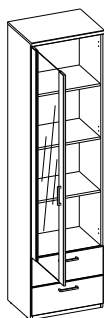

B

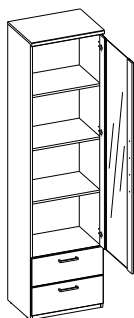



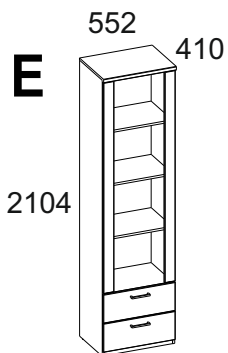
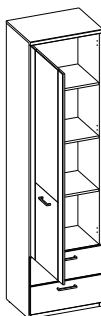

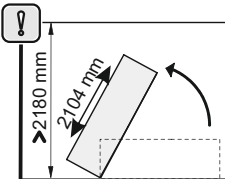
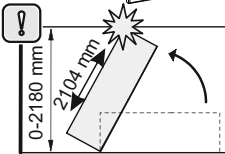
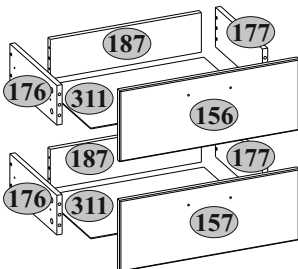
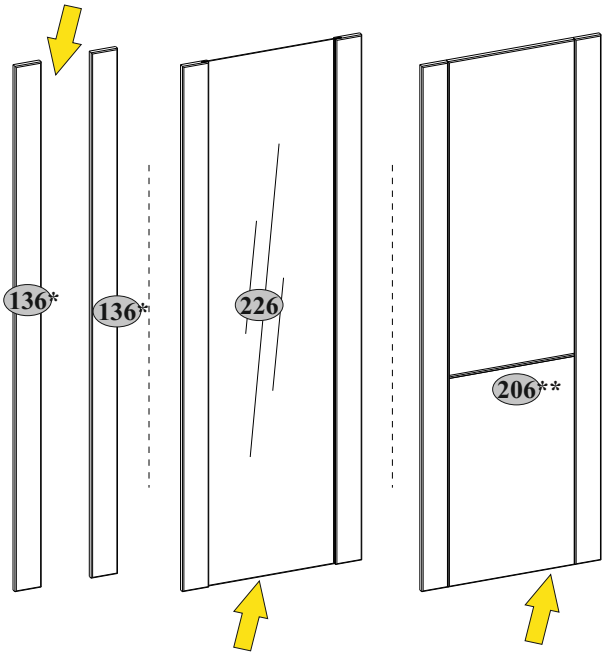
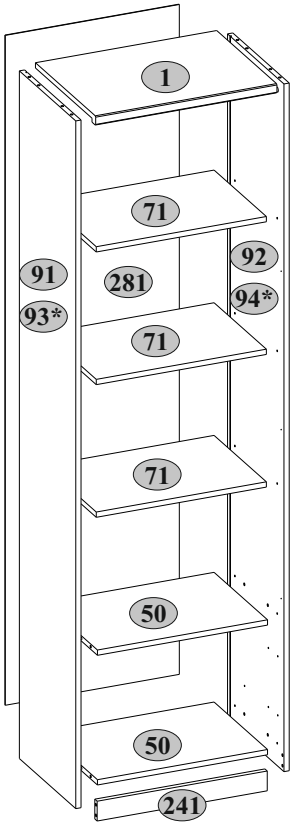



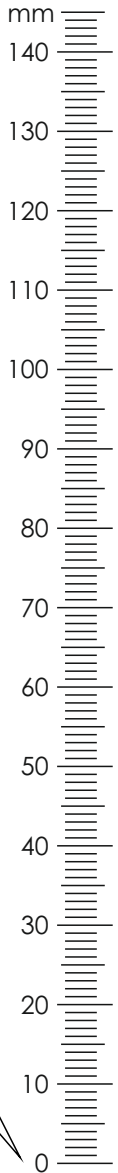





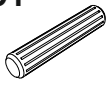
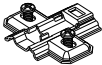
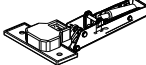



C

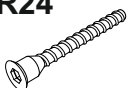

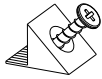

	L, mm	B, mm	H, mm	Q	
1	552	400	32	1	1/2
50	518	364	16	2	1/2
71	518	356	16	3	1/2
91(93*)	2084	384	16	1	2/2
92(94*)	2084	384	16	1	2/2
136*	1592	80	16	2	2/2
156	546	216	16	1	2/2
157	546	216	16	1	2/2
176	320	120	16	2	1/2
177	320	120	16	2	1/2
187	460	120	16	2	1/2
241	518	60	16	1	2/2
206**	546	1592	16	1	2/2
226	546	1592	16	1	2/2
281	2030	530	2,5	1	2/2
311	490	325	2,5	2	1/2

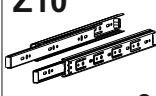

A1  7x34 20	A2  Ø15x12 20	B5  10x50 1	C1  8x35 24
D1-1  3(0*,3**)	E1-1  3(0*,3**)	I  S4 1	H58  3(2*,3**)
N1  4	P5  12	R3  3x20 20	R23  6,3x13 6(0*,6**)
R24  7x50 8	R27  5,0x13 20	R32  4x27 6(4*,6**)	R102  3,5x16 8(18*,8**)
S1  22	S5  Ø18 12	S11  Ø8 8(0*,8**)	U  130x35x15 1
U21  26x26x20 0(8*,0**)			Z10  300 2

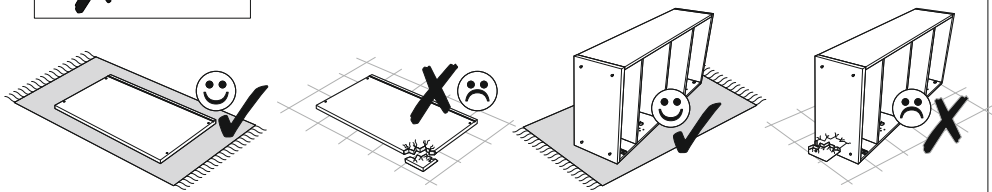
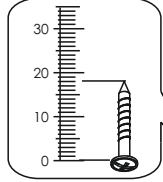
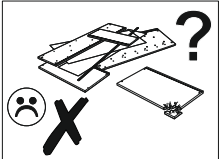
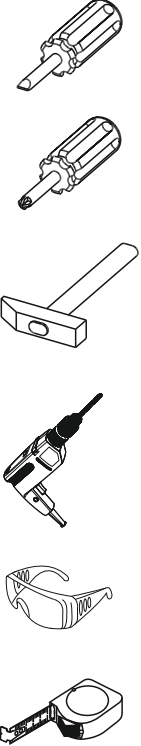

1

A1



7x34

C1

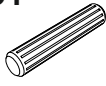

8 8x35

N1



4

P5



4 12

R27



5,0x13 12

Z10

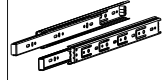

300 2

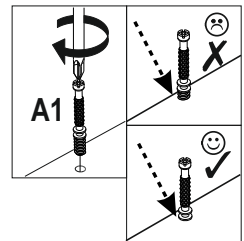
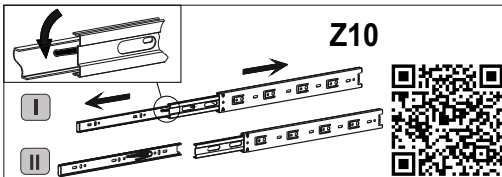
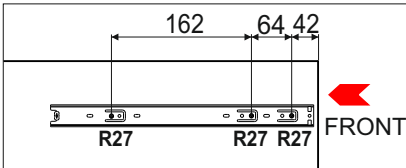
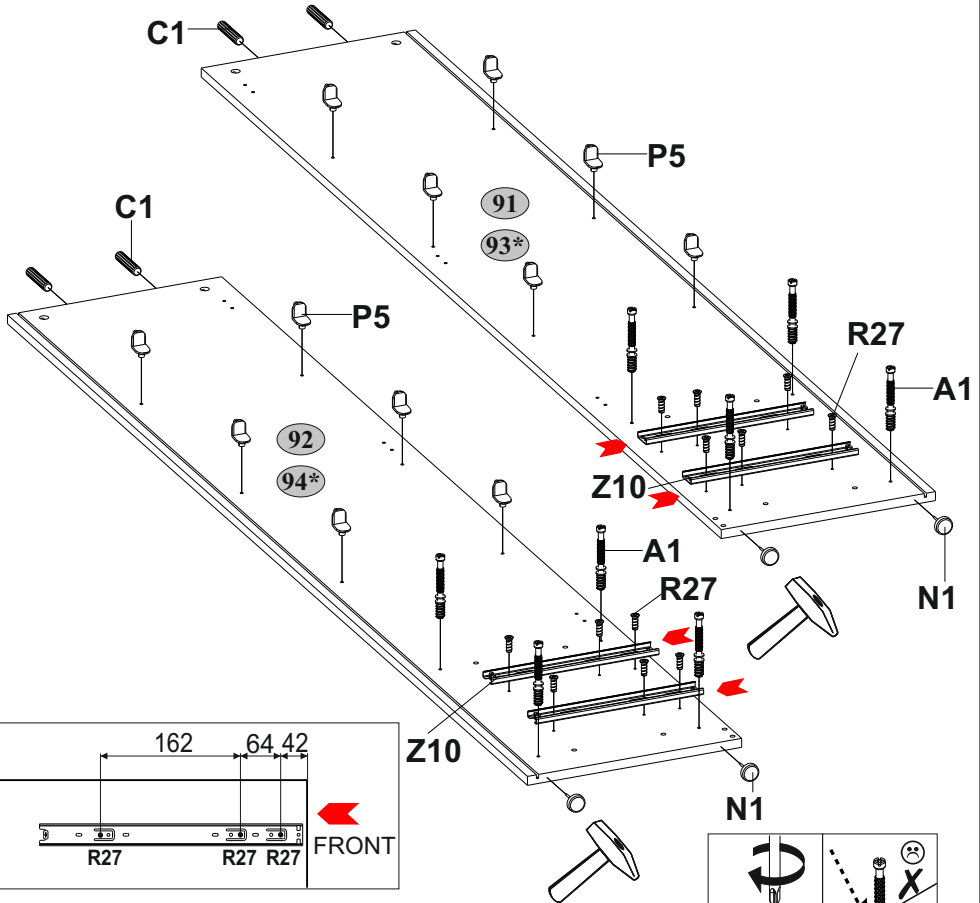
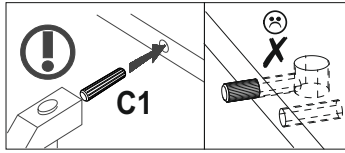

2

C1

8x35

12

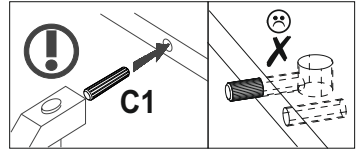
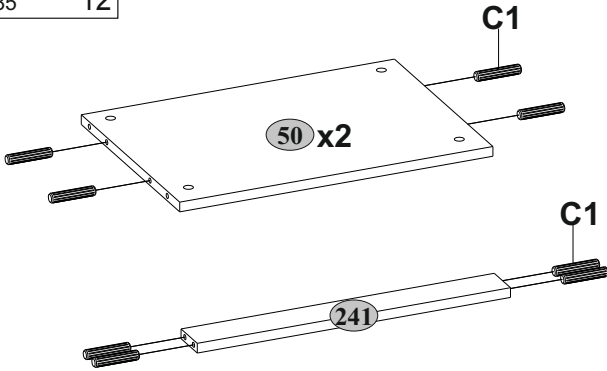

3

A1

7x34

4

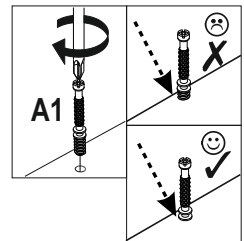
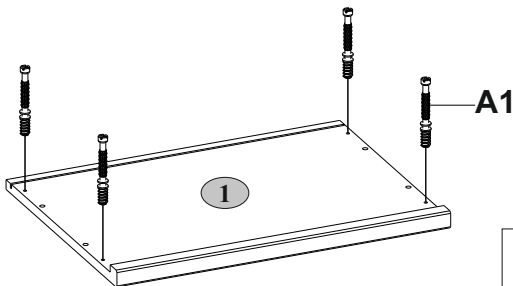

4

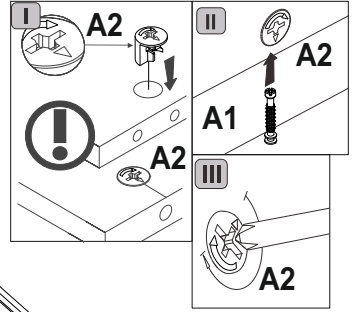
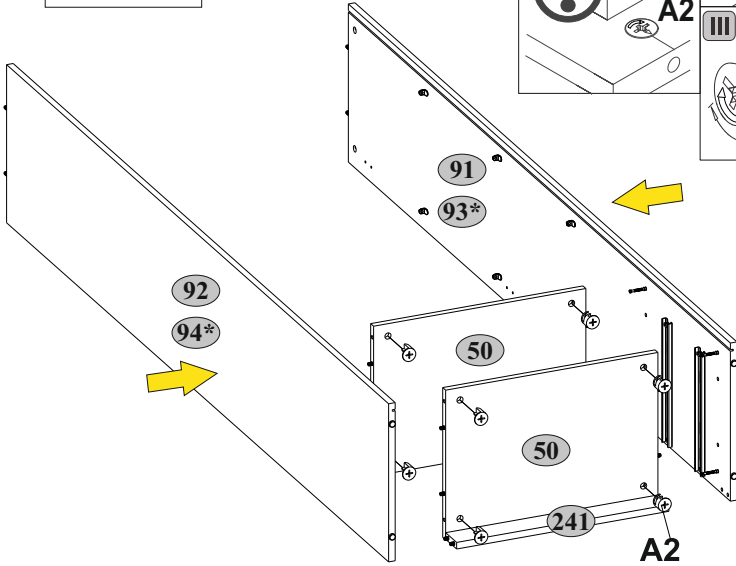
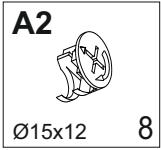

5

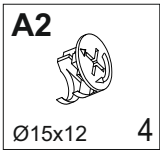
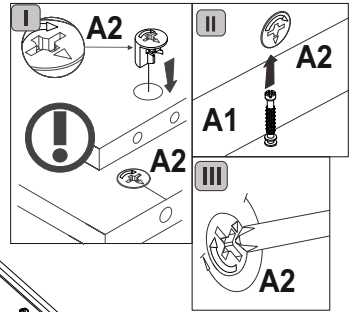
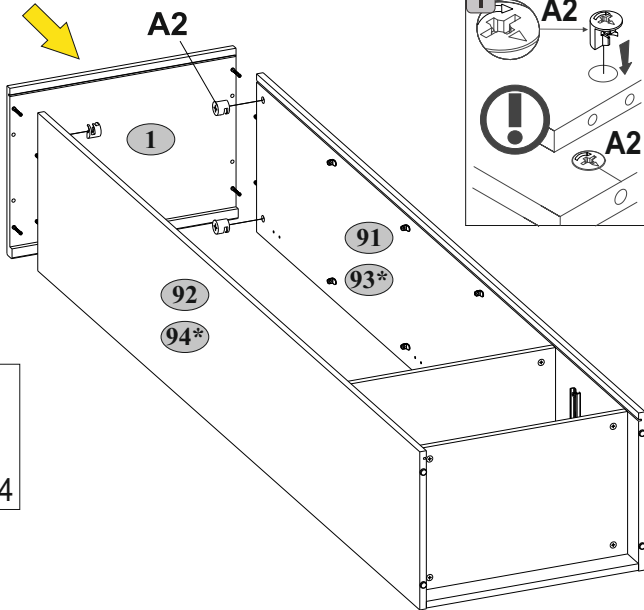

6

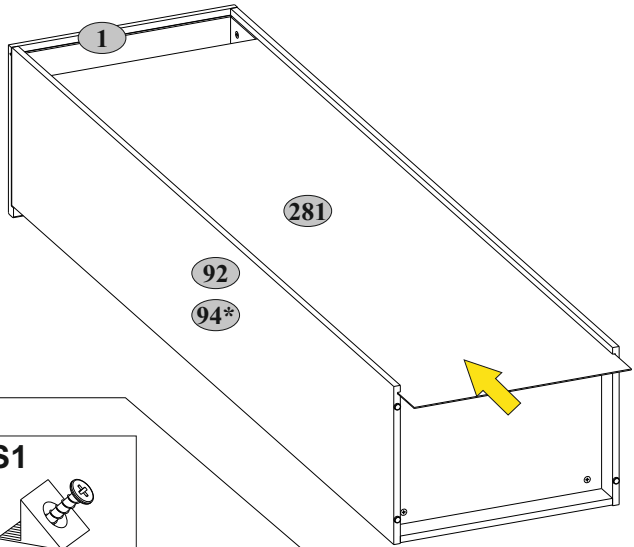



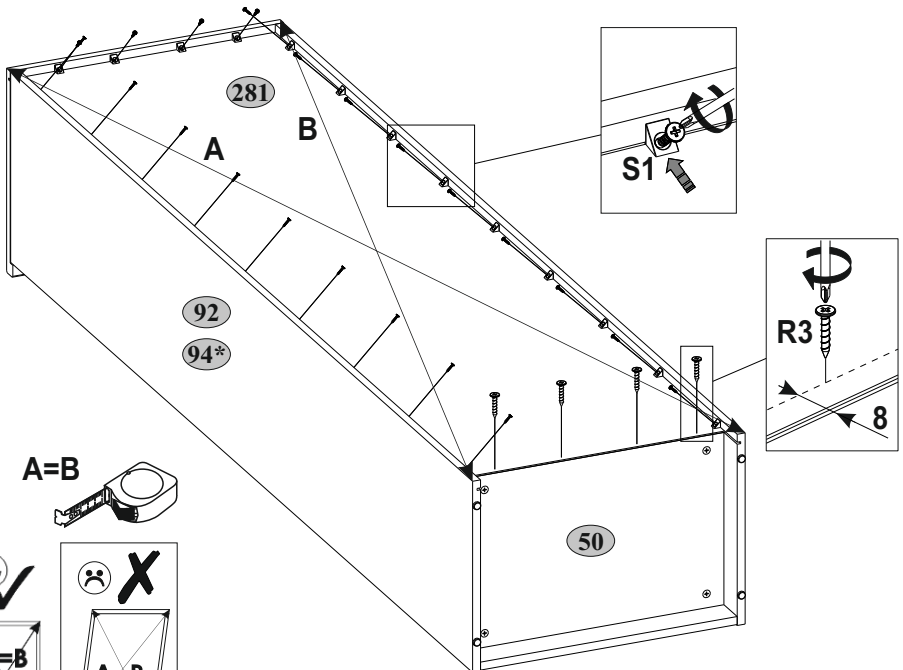
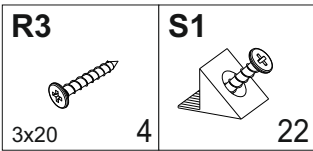





7

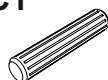

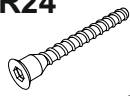
8

x2

A1  7x34 8	A2  Ø15x12 8	C1  8x35 8	I  S4 1	H58  2
R24  7x50 8	R27  5,0x13 8	R32  4x27 8	S5  Ø18 4	Z10  300 2

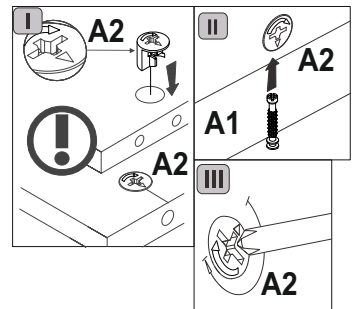
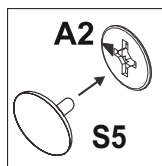
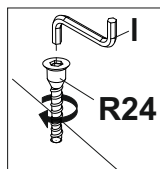
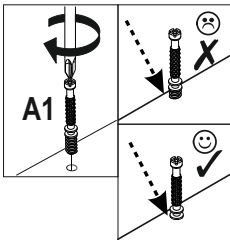
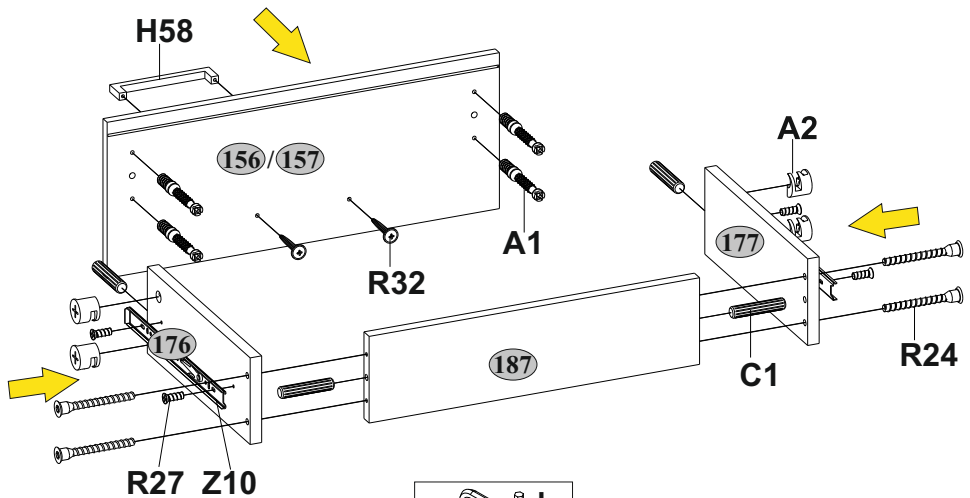
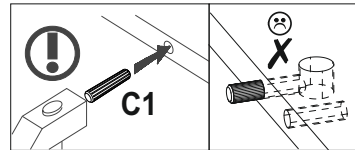
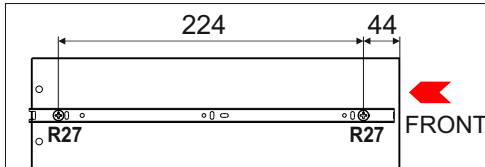

9

x2

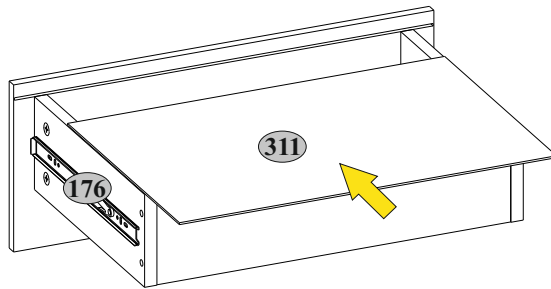

10

x2

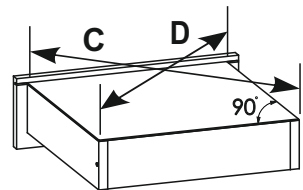
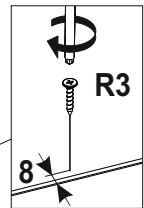
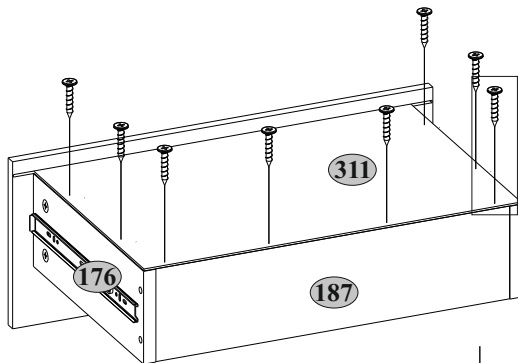
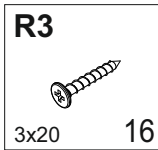

11

B5



10x50

1

R102



3,5x16

2

S5



Ø18

U





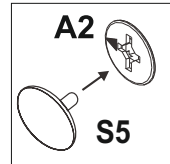
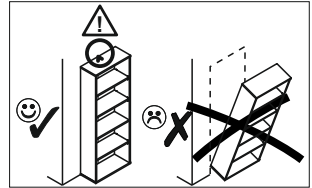
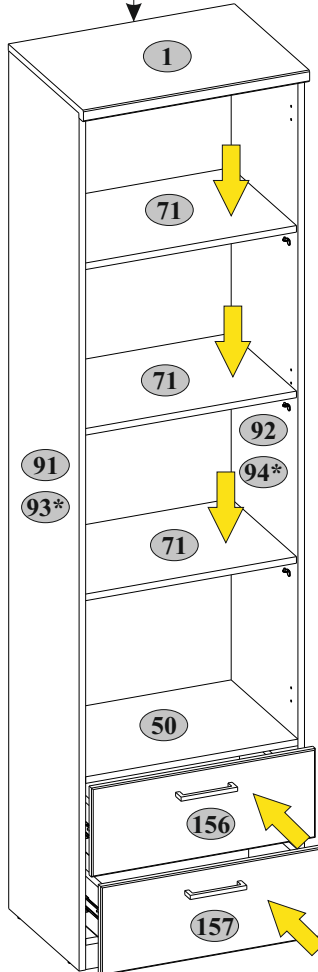
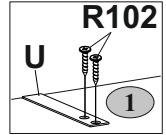
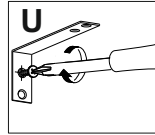
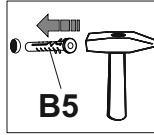
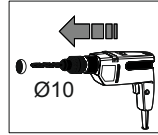
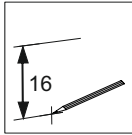
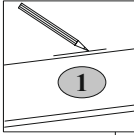

130x35x15

1

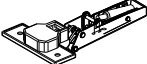

1	50	max. 5 kg
71	156 157	

12

E1-1  3	H58  1	R32  4x27	R102  3,5x16	S11  2
---	--	---	--	--

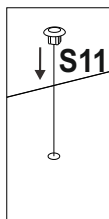
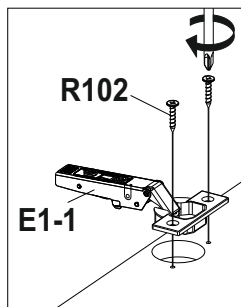

A

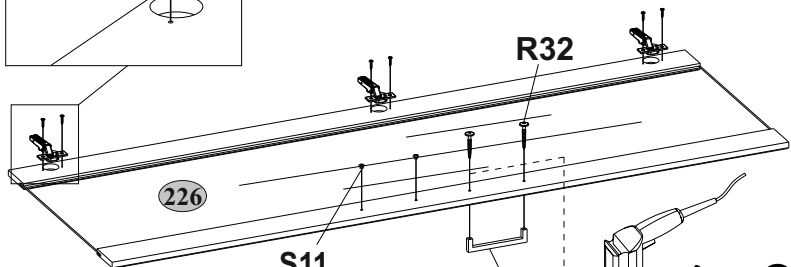
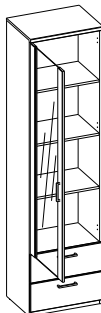



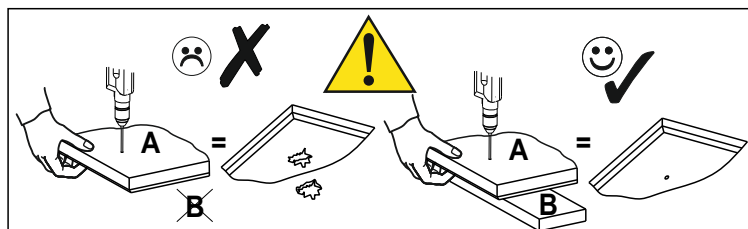
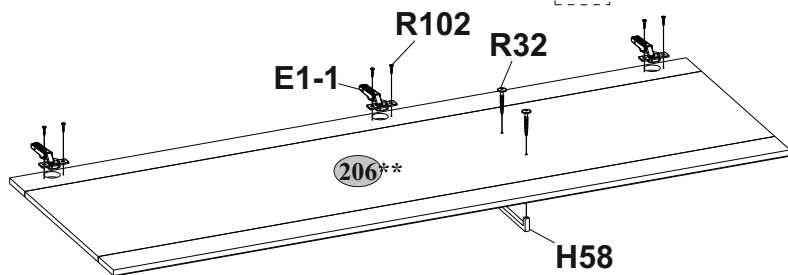

C

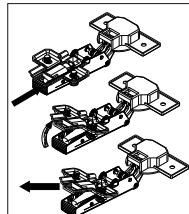

E1-1+D1-1



12

E1-1  3	H58  1	R32  4x27	R102  3,5x16	S11  2 Ø8
---	--	---	--	--

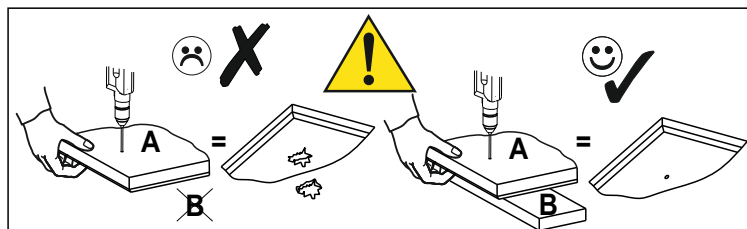
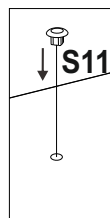
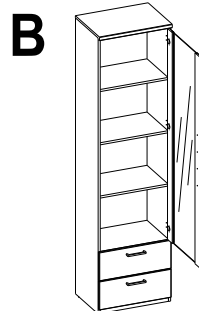
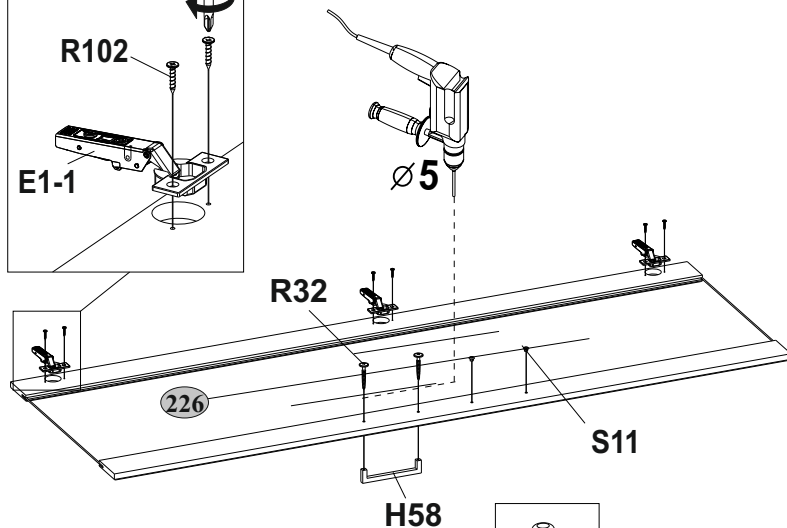
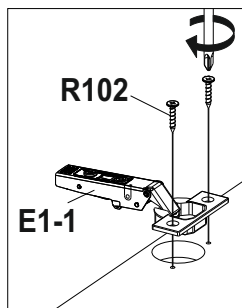

E1-1+D1-1

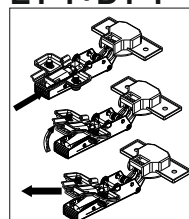

13

D1-1

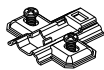

3

R23



6,3x13

S11



6 Ø8

6

B

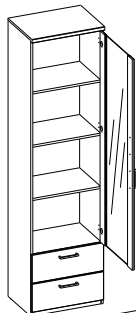

A

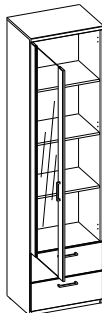

C

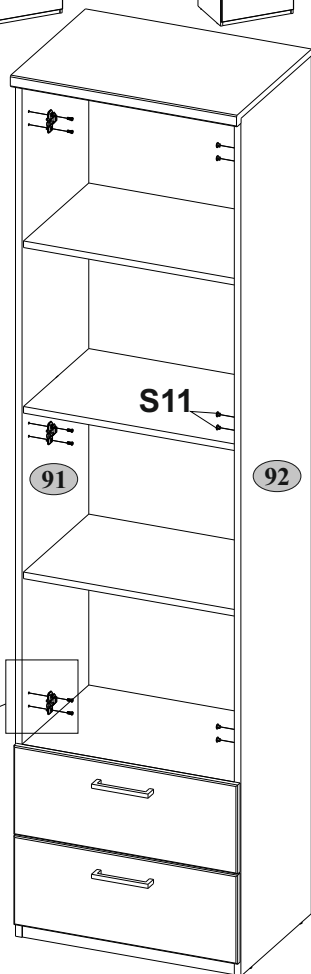
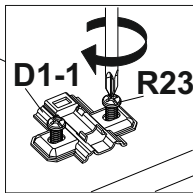
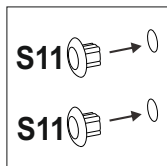
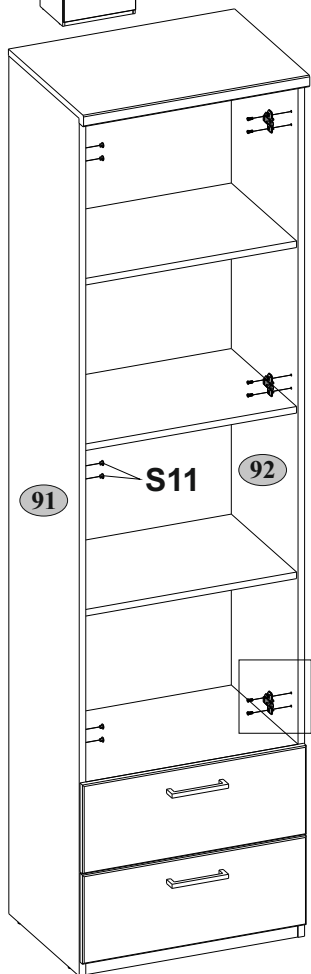
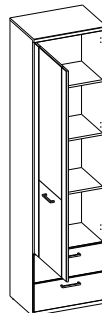

14

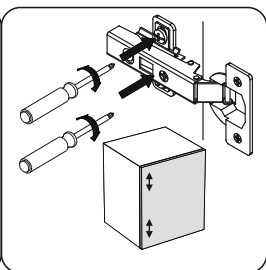
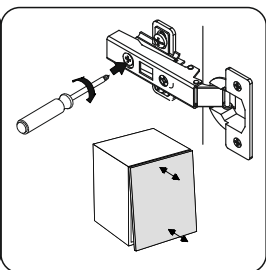
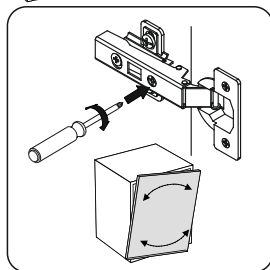
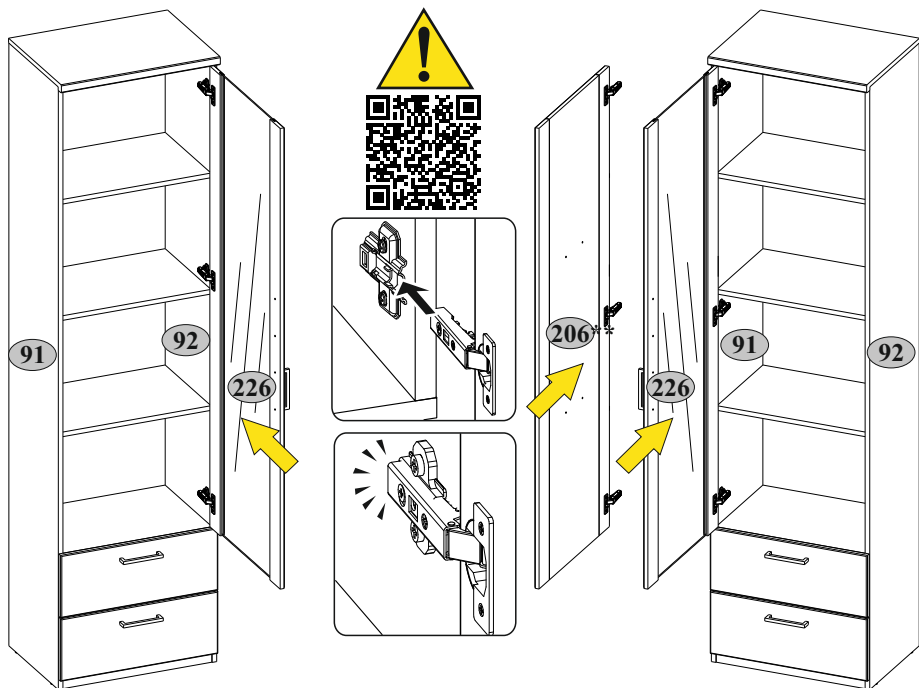
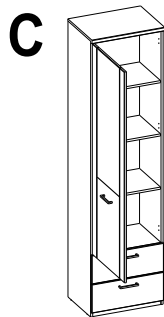
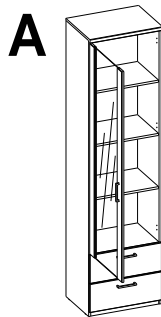
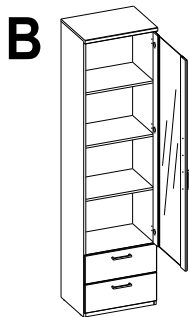

12

x2

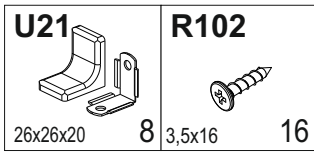

E

